

Remote display



for

solar charge controller

for two batteries

12 V/24 V 20 A

(not included)

Installation and operating instructions

1 About these instructions

This document is part of the product.

- Read the installation and operating instructions carefully before use.
- Keep the installation and operating instructions in the vicinity of the product over the entire lifetime of the product.
- Pass the installation and operating instructions on to every subsequent user of the product.

Description of symbols

Safety instructions are labelled as follows:



Keyword

Measures for avoiding danger

2 Safety

Designated use

The remote display may only be used exclusively as an operating and display device in conjunction with the solar charge controller for two batteries 12 V/24 V 20 A.

The remote display may only be operated indoors.

The USB charging socket on the top side of the device may only be used for charging battery powered devices within the USB specifications.

The micro USB socket may only be used by technical personnel for servicing purposes.

Connecting the remote display to a network (LAN) is not permitted and can cause damage.

If the cable supplied is not long enough, a standard Cat5 patch cable (max. 10 m long) with straight RJ-45 plugs can be used.

Safety instructions

The factory-applied labels on the device must not be modified or removed.

Improper operation can reduce the yields of the solar energy system. System components can be damaged.

Do not touch the green conductor area with the device connections on the electronic module. Electrostatic discharges can cause irreversible damage to the device.

The remote display can be used for changing the solar charge controller settings relating to the connected batteries and solar modules. Observe the specifications and safety instructions of the solar charge controller, the batteries and the solar modules.

The device must be taken out of operation if damage to the device, the cables or other system components is evident. If the device is damaged (not functioning or visible damage, smoke etc.) it must be returned to the dealer or manufacturer for repair. If the cable is damaged, it must be replaced before placing the device back into operation.

3 Description

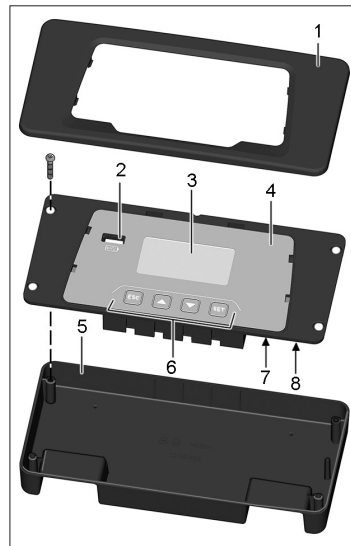

- 1 Cover
- 2 USB charging socket
- 3 Display
- 4 Bracket with electronic module
- 5 Lower casing
- 6 Operating buttons
- 7 Micro USB socket (for servicing only)
- 8 Connection for solar charge controller

The type plate with the CE identification is located to the right of the display on the electronic module.

The procedure for removing the cover is described in Section 4.

After mounting, the remote display is connected to the solar charge controller using the cable provided.

The remote display provides convenient display and operation of the solar charge controller and extends the functionality of this device.

Information is displayed both graphically and as text. The remote display is operated using four buttons.

A user-friendly menu structure guides the operator through the comprehensive range of display and control functions:

- Display of measured values for monitoring and analysis
- Setting of operating modes and special functions of the solar charge controller
- Setting or changing the type of batteries connected to the solar charge controller
- Logging and saving of yield data
- Logging and saving of load data
- Display of device information, notes and error messages

Measured values and messages are stored in internal memory. These values are retained, even when the remote display is taken out of operation.

The USB charging socket can be used for charging battery powered devices having a USB connector (e.g. smartphone).

4 Installation

The remote display can be used as a:

- Handheld device
- Recess mounted device
- Surface mounted device

Handheld device

Connect the remote display to the solar charge controller using the cable supplied (see Section "Connection").

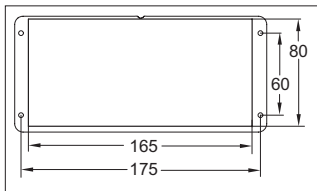
Recess mounted device

Dimensioned drawing for required cutout
Hole diameter: approx. 2 mm
(depending on the screws used)



Do not touch the green conductor area with the device connections on the electronic module. Electrostatic discharges can cause irreversible damage.

1. Prepare the recessed mounting surface according to the dimensioned drawing.
2. Remove the cover (see Section "Removing the cover").
3. Unscrew the four screws and remove the lower casing.
4. Connect the cable supplied to the remote display, then route it through the cutout and to the solar charge controller (see Section "Connection").
5. Insert the electronic module in the cutout and fasten with the four screws. Take appropriate measures to prevent accidental touching of the rear side of the electronic module (fit a cover if necessary).
6. Press the cover onto the electronic module and allow it to latch into place (see Section "Fastening the cover").

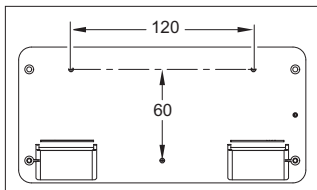
Surface mounted device

Dimensioned drawing for holes in casing base
The fastening material required depends on the mounting surface.

Important: Screw head height: maximum of 3.5 mm

1. Remove the cover (see Section "Removing the cover").
2. Unscrew the four screws and remove the lower casing.
3. Drill holes in the casing base at the three marked fastening positions. The fastening positions are pre-formed to provide accurate centring of the drill bit.
4. Place the casing base as a template horizontally level on the desired mounting surface and mark the position of the required mounting holes through the holes in the casing base.
5. Drill the required holes in the mounting surface.
6. Fasten the casing base to the mounting surface with three screws.
7. Insert the electronic module in the case and fasten with the four screws supplied.
8. Press the cover onto the electronic module and allow it to latch into place (see Section "Fastening the cover").
9. Connect the remote display to the solar charge controller using the cable supplied (see Section "Connection").

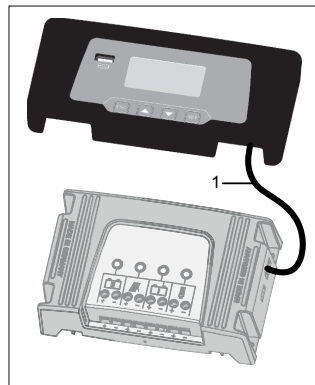
Connection

1. Insert the plug of the cable supplied (1) into the "StecaLink" connector of the remote display.
2. Lay the cable (1) so that it is not kinked and is not under strain.
3. Insert the plug of the cable supplied (1) into the "StecaLink" connector of the solar charge controller.

Fastening the cover

1. Fit the cover onto the electronic module.
2. Align the four latches to the openings in the electronic module and latch the cover into place by pressing lightly.

Removing the cover

1. Press lightly against the cover on one side.
2. Lift off the cover upwards at the other side.

5 Operation

The remote display switches on automatically when the cable to the solar charge controller is plugged in and battery 1 is connected to the solar charge controller. When the remote display is not operated, the display backlighting automatically switches off after a period of 30 seconds.

NOTE Press any button to reactivate the device.

Initial commissioning

The following basic settings should be made when the remote display is started for the first time:

- Menu language
- Time/date

This is displayed as a warning if a valid time / valid date has not been set.

The display shows a corresponding message if the settings of the solar charge controller and the remote display are different. After pressing "SET", the operator can choose whether the remote display settings or the solar charge controller settings are to be used in the future.

After making the basic settings, the status display is shown.



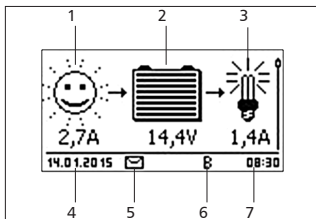

Status display

The status display consists of the "Basic position" and the pages with the measured values.

Basic position:



- 1 One of the following symbols is displayed, depending on the status of the solar module and the system:

-  The solar module is illuminated, the solar charge controller has detected the "Day" condition. No event message or a message of type "Information" is present.
-  The solar module is illuminated, the solar charge controller has detected the "Day" condition. An event message of type "Warning" or "Error" is present.
-  The solar module is not illuminated, the solar charge controller has detected the "Night" condition. No event message or a message of type "Information" is present.
-  The solar module is not illuminated, the solar charge controller has detected the "Night" condition. An event message of type "Warning" or "Error" is present.

The input current in amperes is displayed below this.

- 2 The *Battery* symbol indicates charging of the battery as follows:



Battery almost full



Battery almost empty

The current battery voltage in volts is displayed below this.

- 3 The *Load* symbol is shown when the output is switched on.

The load current in amperes is displayed below this.

- 4 Date
- 5 Symbol for *Non-confirmed event messages*
- 6 Symbol for the currently executed charging function:
 "E": "Equal charge"
 "F": "Float charge"
 "B": "Boost charge"

- 7 Time

To page through the measured value pages: press $\triangle \nabla$.

5.1 General operation

After switching on the remote display, the basic position of the status display is shown.

When the remote display is not operated, the display backlighting automatically switches off after a period of 30 seconds.

NOTE Press any button to reactivate the device.

Proceed as follows to navigate from the status display into the menu system:

- To display the measured values: press $\triangle \nabla$.
- To display the main menu: press "SET". The top entry is selected.
- To select a different entry: press $\triangle \nabla$.
- To select a submenu: press "SET".
- To jump back to the basic position of the status display: press and hold "ESC" for 1 second. The jump back to the basic position always occurs, regardless of the current menu position.

Menu navigation

Operating buttons

Button	Action	Function
ESC	Press briefly	Jumps up by 1 menu level Discards changes
	Press longer (≥ 1 second)	Jumps to status display
\triangle	Press briefly	<ul style="list-style-type: none"> • Moves the selection bar or the display content upwards • Moves the selection 1 position to the left when entering numeric values • Increases the setting value by 1 step
	Press longer (≥ 1 second)	Jumps to status display
∇	Press briefly	<ul style="list-style-type: none"> • Moves the selection bar or the display content downwards • Moves the selection 1 position to the right when entering numeric values • Decreases the setting value by 1 step
	Press longer (≥ 1 second)	Jumps to status display
SET	Press briefly	<ul style="list-style-type: none"> • Marked menu item is selected • A selected numerical value starts flashing and can be changed • Accepts any entered changes • Changes the state of a control element (check box/radio button)
	Press longer (≥ 1 second)	Answers a query dialogue with Yes

5.2 Menu structure

For the sake of clarity, only the operating buttons ▾ and "SET" are illustrated.

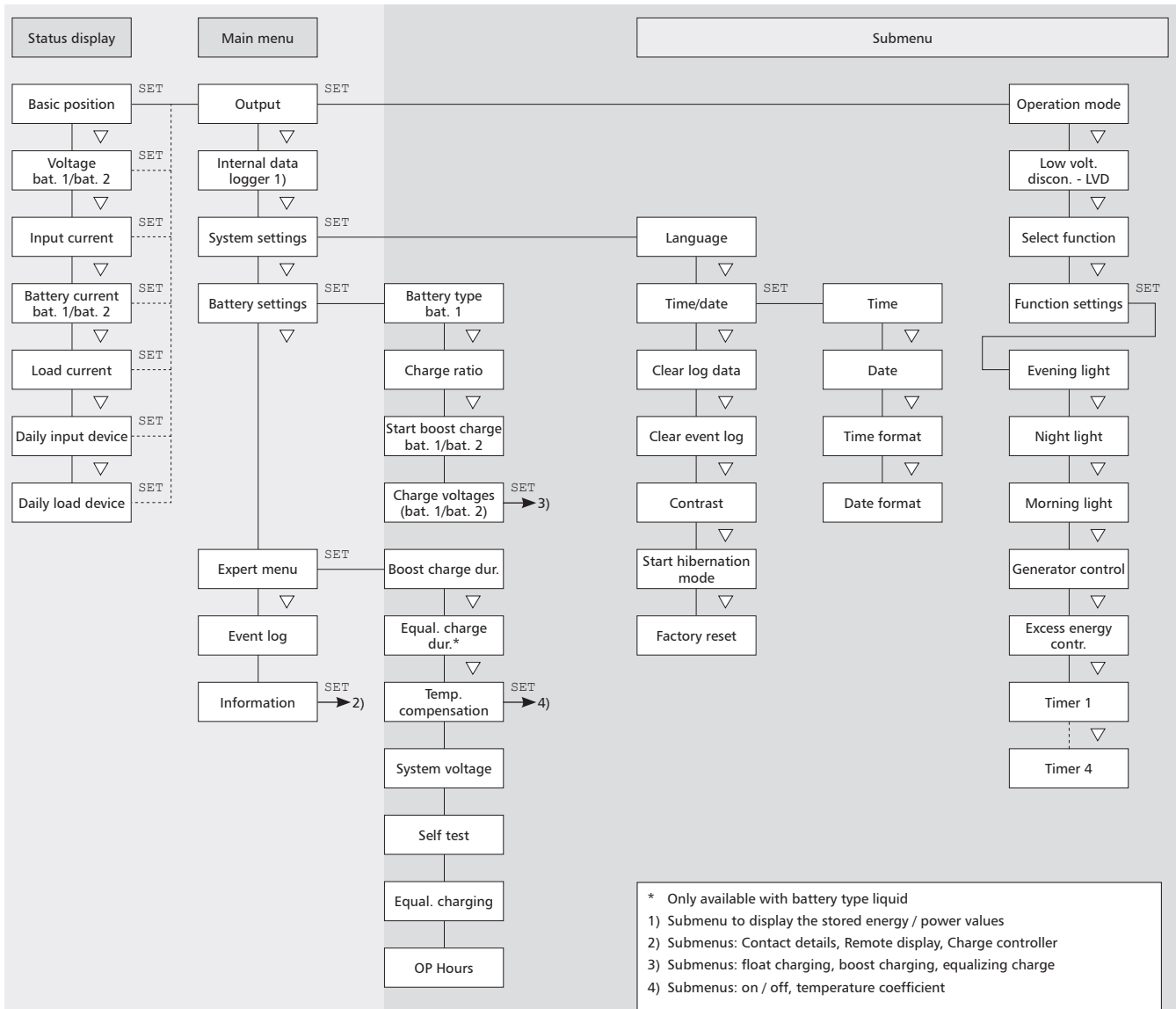

5.3 Settings for the output

1. Select "Main menu" ► "Output" ► "Operation mode".
2. Press Δ / ∇ to select "On", "Off" or "Function".
3. Press "SET" to confirm the selected function.

Other possible settings:

5.3.1 Low voltage disconnect

The low voltage disconnect switches the output on and off at a higher level of priority, independently to the control functions.

The low voltage disconnect switches the output off when the switch-off threshold is reached and switches it on again when the battery charge state is the switch-on difference greater than the switch-off threshold.

5.3.2 Select function

Select the desired function, e.g. "Evening light", "Night light" and "Morning light".

The switched-on control functions only take effect in the "Function" operating mode.

NOTE With all brightness-based control functions, the required brightness information is obtained from the solar module.

5.3.3 Function settings

Setting of switching times, switching duration, switch-on and switch-off thresholds for the following control functions:

- Evening light
- Night light
- Morning light
- Generator control
- Excess energy contr.
- Timer (4 independently programmable timers)

Switch control functions individually on and off

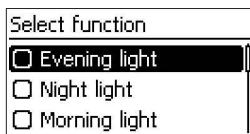

1. Select "Main menu" ► "Setting outputs" ► "Select function".
2. Press ∇ / Δ to select and then press "SET" to switch the control functions on and off (Fig. left).

Note

The switched-on control functions only take effect in the "Function" operating mode.

3. Press "ESC" to leave the page.

Setting control functions

Note Setting of the control functions is described below using Evening light and Timer 1 as examples.

Set evening light (see Section "Evening light function")

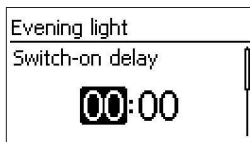

1. Select "Main menu" ► "Charging port" ► "Function settings".
2. If necessary, press ∇ / Δ to select "Evening light".
3. Press "SET". The "Switch-on delay" dialogue appears.

4. Press "SET", use ∇ / Δ to set the switch-on delay hours and confirm with "SET".
5. Press ∇ . The minutes are selected.
6. Press "SET", use ∇ / Δ to set the minutes and confirm with "SET".

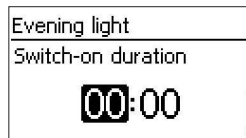

Setting Timer 1 (see Section "Timer 1 ... 4")



7. Press ∇ . The "Switch-on duration" dialogue appears.
8. Press "SET", repeat steps 4 to 6 for the switch-on duration.
9. Press "ESC". The "Function settings" menu appears.
1. Select "Timer 1".
2. Press "SET". The "Switch-on time" dialogue appears and the selected day is underlined.
3. If necessary, press ∇ / Δ to select a different day.
4. Press "SET". The state of the selected day changes (Fig. left: Monday is switched on).
5. Press ∇ / Δ to select a different day.
6. Repeat steps 4 to 5 until all days are switched on for which the switch-on time is to apply.
7. Press ∇ (several times if necessary) until the hour display of the switch-on time is selected.
8. Press "SET", then use ∇ / Δ to set the hour and confirm with "SET".
9. Press ∇ . The minutes are selected.
10. Press "SET", then use ∇ / Δ to set the minute and confirm with "SET".
11. Press ∇ . The "Switch-off time" dialogue appears.
12. Set the day and time of the switch-off time in the same manner as described in steps 3 to 10.
13. Setting of the Evening light and Timer 1 control functions is now finished. Press "ESC" to leave the page.

Evening light function

The evening light function switches the output on and off based on the brightness and time. The reference point is the time of dusk. The evening light function is suitable for loads that are operated a certain time after nightfall, e.g. lighting, heating.

Switching behaviour

- The output remains switched on during the switch-on duration (6) (Fig. below) but the switch-on is delayed by the switch-on delay (5).
- When dawn is detected the output is switched off, even if the switch-on duration has not expired.

Operation

Selection: "Main menu" ► "Output" ► "Select function"

Setting: "Main menu" ► "Output" ► "Function settings" ► "Evening light"

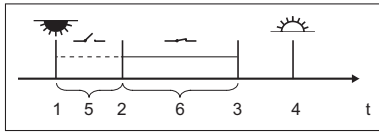

- 1 Dusk
- 2 Switch-on time
- 3 Switch-off time
- 4 Dawn
- 5 Switch-on delay
- 6 Switch-off delay

Night light function

The night light function switches the output on and off based on the brightness and time. The reference points are the times of dusk and dawn. The night light function is suitable for loads that are only operated at night, e.g. emergency lighting.

Switching behaviour

The output is switched on at the switch-on delay (5) (Fig. below) after dusk and switched off at the switch-off delay (7) before dawn. See below for the dawn time.

Operation

Selection: "Main menu" ► "Output" ► "Select function"

Setting: "Main menu" ► "Output" ► "Function settings" ► "Night light"

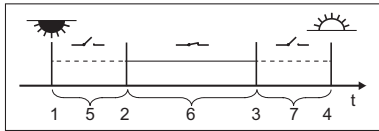

- 1 Dusk
- 2 Switch-on time
- 3 Switch-off time
- 4 Dawn
- 5 Switch-on delay
- 6 Switch-off time
- 7 Switch-off delay

Morning light function

The morning light function switches the output on and off based on the brightness and time. The reference point is the time of dawn. The morning light function is suitable for loads that are operated a certain time before dawn, e.g. heating, feeding system, bus-stop lighting.

Switching behaviour

- The output remains switched on during the switch-on duration (5) (Fig. below) and is switched off by the switch-off delay (6) before dawn.
- When dawn is detected the output is switched off, even if the switch-on duration has not expired.

Note The morning light function relates to the time of dawn, but the resulting switching time lies before dawn, i.e. in the past. For this reason, the controller must have performed at least one night-day changeover before the morning light function can be executed. After this, the controller continuously adjusts the time of dawn to suit any changes (weather, annual changes to the length of the day, disconnection/covering of the solar module).

Operation

Selection: "Main menu" ► "Output" ► "Select function"

Setting: "Main menu" ► "Output" ► "Function settings" ► "Morning light"

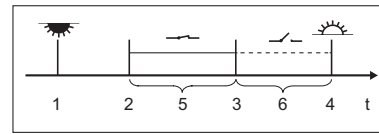

- 1 Dusk
- 2 Switch-on time
- 3 Switch-off time
- 4 Dawn
- 5 Switch-on duration
- 6 Switch-off delay

Excess energy control

The excess energy control switches the output on as long as the battery has a high state of charge. The excess energy control is suitable for non-critical loads that can be specifically switched on when a surplus of energy is available, e.g. electric water heating, auxiliary cooling or heating devices.

Switching behaviour

The output is switched on when the switch-on threshold is reached (1) (Fig. below) and is switched off when the charge state drops the switch-off difference (2) below the switch-on threshold.

Operation

Selection: "Main menu" ► "Output" ► "Select function"

Setting: "Main menu" ► "Output" ► "Function settings" ► "Excess energy contr."

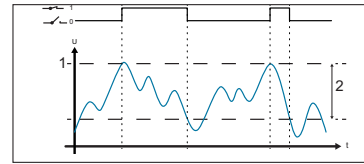

- 1 Switch-on threshold
- 2 Switch-off difference

Generator control

The generator control switches the output on as long as the battery has a low state of charge.

The generator control is suitable for a generator that is switched on when the battery is at a low state of charge.

Switching behaviour

The output is switched on when the charge state is below the switch-on threshold (1) (Fig. below) and is switched off when the charge state reaches the switch-off difference (2) above the switch-on threshold.

Operation

Selection: "Main menu" ► "Output" ► "Select function"

Setting: "Main menu" ► "Output" ► "Function settings" ► "Generator control"

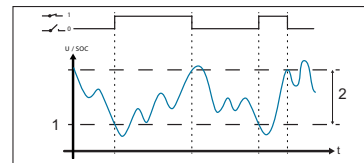

- 1 Switch-on threshold
- 2 Switch-off difference

Timer 1 ... 4

The timers can be used to switch the outputs on and off at specific times in a weekly cycle. The switch-on and switch-off times for each weekday can be separately defined for each timer.

Switching behaviour

The switch-on and switch-off times can be defined for different days of the week. This allows switch-on or switch-off durations of several days.

Operation

Selection: "Main menu" ► "Output" ► "Select function"

Setting: "Main menu" ► "Output" ► "Function settings" ► "Timer 1 – 4"

5.4 Data logger

The data logger stores the following data in its internal memory:

- Input energy (the energy supplied by the solar module (last 18 h, day, month, year, total))
- Load energy (the energy output (last 18 h, day, month, year, total))
- Min. battery voltage (battery 1, last 30 days)
- Max. battery voltage (battery 1, last 30 days)
- Max. input current (last 30 days)
- Max. load current (last 30 days)

The stored data is displayed as selected.

To clear the stored data, select "Main menu" ► "System settings" ► "Clear log data" and then confirm with "SET" (hold pressed for 1 s).

5.5 System settings

This menu item provides access to the following settings:

- Language: selects the menu language (German/English)
- Time/date with setting of the time/date format
- Clear log data: deletes the stored energy values and maximum/minimum values
- Clear event log: deletes all messages (Information, Warning, Error)
- Contrast: setting to adjust the legibility of the display
- Start hibernation mode
- Factory reset: resets all configurable values to the factory default settings

Note "Hibernation mode" switches the solar charge controller into the energy-saving mode and switches off the remote display. "Hibernation mode" is entered automatically after 48 hours without solar voltage at the solar charge controller or manually when selected in the remote display menu.

The device wakes up or returns to "Normal mode" no later than 30 minutes after solar voltage is applied or by performing a "Reset" (switching off the charge controller power supply for a few seconds).

5.6 Battery settings

This menu item provides access to the following settings:

- Battery type (battery 1): liquid or solid electrolyte in battery 1
- Charge ratio: percentage value for the distribution of charge between battery 1 and battery 2
- Start boost charge battery 1/battery 2: start boost charging for selected battery
- Charge voltages battery 1/battery 2: limit values for float charging, boost charging and equalizing charge

5.7 Expert menu



Danger of damaging the system.

The expert menu allows modification of settings that require specialist technical knowledge. The expert menu must therefore only be used by professional personnel who know the applicable regulations and standards.

1. Select "Main menu" ► "Battery settings" ► "Expert menu".
2. Press "SET". The password entry dialogue is displayed and the 1st digit from the left is selected.

Note The password is 17038.

3. Press "SET".
4. Set to "1" using ∇△ and confirm with "SET".
5. Press ∇ to select the 2nd digit from the left.
6. Press "SET".
7. Set to "7" using ∇△ and confirm with "SET".
8. Repeat steps 5 to 7 for the other digits.
9. Press and hold "SET" for 1 second. The Expert menu appears.
10. Press ∇△ to select an entry.
11. Press "SET" to open the entry.

Self test

The self test checks the main device functions.



Disconnect the loads from the solar charge controller before starting the self test.

1. Select "Main menu" ► "Expert menu" ► "Self test".
2. Press and hold "SET" for 1 second. The self test starts,  is displayed.
3. If no errors occurred, the message "Self-test has been successfully completed" appears. If an error occurs, this is displayed in the usual manner (see Section "Faults and remedies"). The message "Self-test failed" appears. Press "ESC".
4. Press "ESC".
5. If the remote display has displayed the message "Self-test failed": eliminate the fault using the information in the event messages ("Main menu" ► "Event log").
6. Reconnect loads.

5.8 Event log

This menu item allows the list of current and acknowledged messages to be displayed. The entries are sorted by the time of their occurrence. When paging through the messages, the display returns to the first message after reaching the last message.

5.9 Company Information and System Information

The entries contain the following information:

- Contact details: manufacturer address
- System information: serial number and version overview of the remote display and the solar charge controller

6 Maintenance

When necessary, clean the device using only a damp, lint-free cloth. Do not use cleaning agents.

Apart from surface cleaning, the device is maintenance-free.

7 Faults and remedies

Errors detected by the device are indicated via event messages. With "Warning" and "Error" events the display blinks red. The following table contains information on correcting errors.

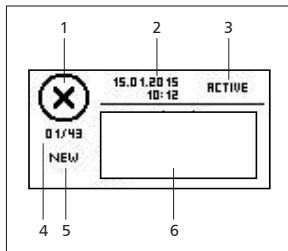

1 Event message type:

- Information, Warning,
- Error

2 Time at which the event occurred (date/time)

3 Time at which the cause of the event message was eliminated (date/time), or "ACTIVE" if the cause of the event message is still present

4 Number of the displayed event message / Total number of event messages (max. number of all event messages = 30)

5 "NEW" (if the event message has not been confirmed)

6 Area for the message number and message text

New event messages are displayed immediately. The event messages disappear after they have been confirmed or their causes have been corrected.

If messages exist whose cause has been corrected but have not yet been confirmed then is shown in the information bar of the status display.

Confirming event messages (acknowledgement)

An event message with the comment "NEW" is displayed:

- Press "ESC"/ Δ / ∇ . The event message is confirmed.

Displaying event messages

- Select "Main menu" \blacktriangleright "Event log".
- Press Δ / ∇ to page through the event messages.

Clearing the event log

Note All event messages are cleared.

- Select "Main menu" \blacktriangleright "System settings" \blacktriangleright "Clear event log".
- Press "SET". The confirmation query "Are you sure?" appears.
- Press and hold "SET" for 1 second to clear the event log.

Error/Fault message	Cause	Remedy
No display	<ul style="list-style-type: none"> Cable not correctly connected or damaged Battery 1 connected with the wrong polarity or not connected Fuse in solar charge controller blown due to an overload Battery 1 is deeply discharged 	<ul style="list-style-type: none"> Correctly connect or replace the cable Check the battery connection at the solar charge controller Check the battery at the solar charge controller
02 Battery at load output	A voltage source is connected to the output	Check the connection at the solar charge controller

Error/Fault message	Cause	Remedy
03 Over temperature device	Inadequate ventilation at the solar charge controller, excessively high ambient temperature, overload	Check the solar charge controller
04 System voltage mismatch	Impermissible combination of different battery voltages	Check the batteries at the solar charge controller
05 PV overvoltage	Solar module overvoltage	Check the connection at the solar charge controller
06 PV module short circuit	Short circuit at solar module input	
07 Battery 1 voltage too high	Voltage of battery 1 too high	
08 Battery 2 voltage too high	Voltage of battery 2 too high	
09 Overload	Load current too high	
10 PV Current too high	Incorrectly dimensioned solar module/battery	
11 Load short circuited	Short circuit at output	
12 Deep discharge protection active	Battery 1 empty	
13 Wrong PV polarity	Solar module connected with incorrect polarity	
14 Battery 2 wrong polarity	Battery 2 connected with the wrong polarity	
42 No communication to charger	Cable defective	Correctly connect or replace the cable
43 Time/date lost	Supply voltage disconnected for too long	Set the time and date
26 Interrupted self-test, no communication	Communication error during self test (e.g. cable defective)	Correctly connect or replace the cable
31 self-test: fail PV voltage to low	Solar module voltage too low	Check the connection at the solar charge controller
32 self-test: fail electronic fuse Bat 1 defective	Device fault	Solar charge controller usable but with limited functions and without battery 1
34 self-test: fail electronic fuse Bat 1 defective	Device fault	Solar charge controller usable but with limited functions and without battery 2
36 self-test: fail load switch defective	Device fault	Solar charge controller usable but with limited functions and without an output

Please consult your point of sale if the fault cannot be corrected using the measures described.

8 Technical data

Dimensions WxHxD	188 x 88.5 x 28 mm
Weight	220 g
Temperature range	-20 °C to +50 °C The readability of the display can be impaired at temperatures below 0 °C
Storage temperature	-30 °C to +80 °C
Humidity	Max. 95 % relative humidity, non-condensing
Protection class	3
Degree of protection	IP20
Power supply	From the solar charge controller

The device can be irreversibly damaged if operated outside its specifications. This can also cause damage to other components in the photovoltaic system.

9 Disposal

Do not dispose of the device in the normal household waste. Dispose of the device at the collection point provided for this in your country.

The device packaging consists of recyclable materials.

10 Commercial and legal guarantee conditions

In accordance with German statutory regulations, there is a 2-year legal guarantee on this product for the customer.

The manufacturer provides a voluntary 5-year commercial guarantee to the specialist dealer from the date of invoice or receipt. The commercial guarantee applies to products purchased and operated in EU countries or Switzerland.

The seller will correct all manufacturing and material faults that occur in the product during the guarantee period and affect the correct functioning of the product.

Natural wear and tear does not constitute a malfunction. No guarantee can be offered if the fault can be attributed to third parties, unprofessional installation or commissioning, incorrect or negligent handling, improper transport, excessive loading, use of improper equipment, faulty construction work or improper operation or use. Guarantee claims shall only be accepted if notification of the fault is provided immediately after it is discovered. Guarantee claims are to be directed to the seller. The seller must be informed before guarantee claims are processed. For processing a guarantee claim an exact fault description and the invoice / delivery note must be provided.

The seller can choose to fulfil the guarantee either by repair or replacement. If the product can neither be repaired nor replaced, or if this does not occur within a suitable period in spite of the specification of an extension period in writing by the customer, the reduction in value caused by the fault shall be replaced, or, if this is not sufficiently taking the interests of the end customer into consideration, the contract is cancelled.

Any further claims against the seller based on this guarantee obligation, in particular claims for damages due to lost profit, loss-of-use or indirect damages are excluded, unless liability is obligatory by law.



753975